

# Fall Detection Algorithm based on Peaks of Voltage Measurements from the Accelerometer

Jeong T. Ryu<sup>1\*</sup> and Byung H. Moon<sup>2</sup>

<sup>1</sup>Department of Electronic Engineering, Daegu University, Gyeongsan, Korea  
<sup>2</sup>Department of Communication Engineering, Daegu University, Gyeongsan, Korea

## Abstract

According to the Korea Census Bureau, the number of elderly people above the age 65 will reach more than 10 million in 2026. It means that more than 21% of the population in KOREA will reach over 65 years old. It becomes extremely important to take care of the elderly people for the case of health emergency; such as fall or heart attack. In this paper, a simple fall detection system that detects an actual fall direction is implemented. In order to detect the fall situation, 3-axis acceleration sensor (MMA7331) is used in the system. The fall detection algorithm that can classify fall directions such as front, back, left and right fall is proposed. The direction of the fall is decided by examining the acceleration peaks of X and Y directions of the sensor. It is shown that the proposed algorithm successfully detects the front and back fall direction with probability of 96% and 98%, respectively.

**Keywords:** Accelerometer, Acceleration Peak, Fall Detection

## 1. Introduction

In 2007, the Joint Commission on Accreditation of Healthcare Organization (JCAHO) revealed “reduce patient risk of harm resulting from falls” as the important sub-goal<sup>1</sup>. The elderly fall events have become the major public health issue in the world these days. The concerns of the elderly falls grow as the aging population increases<sup>2</sup>. Falls have to account for a significant portion of injuries in hospitalized patients. Fall injuries in a hospital are often severe, due to the nature of the underlying medical condition<sup>3</sup>. According to the Korea Census Bureau, the number of elderly people above the age 65 will reach more than 10 million in 2026. It means that more than 21% of the population in KOREA will reach over 65 years old. Therefore, fall prevention issues have become an important for the safety of the elderly in recent years all over the world including Korea<sup>4</sup>.

Numerous researches have been conducted to implement a real time classification system for the type of human activity related to the data collected from a single triaxial accelerometer. In<sup>5</sup> and<sup>6</sup>, the implementation of

a real-time classification system for the types of human movement associated with the data acquired from a single, waist-mounted accelerometer is presented. The system recognizes the postural orientation of the person and detects events such as walking and falls. Signal Magnitude Area (SMA) was used as basis for identifying activities. The activity recognition system introduced in<sup>2</sup> can classify six daily living activities and transitional events. The feature selection is done by using Relief-F and Sequential Forward Floating Search (SFFS). In order to classify daily activities, various parameters such as Peak value (P), Base length (B), ration between Peak value (P) and Base length (B), post-impact Velocity (V), and so on from acceleration sum vector are defined and used to identify daily activities. A novel algorithm as well as architecture for the fall accident detection and corresponding wide area rescue system based on a smart phone and the third generation network is presented in<sup>2</sup>. In order to realize the fall detection algorithm, the angles and the waveform sequence of the triaxial accelerometer on the smart phone are utilized as the system input. In order to detect a fall, the high frequency component of

\*Author for correspondence

a fall is compared with the normal activities. To extract the high frequency characteristics of a falling event, high-pass filtering and discrete wavelet transform are used<sup>9</sup>. A fall detection system consisting of a triaxial accelerometer and a smart phone to detect dangerous fall is shown in<sup>10</sup>. The time-domain parameters such as peak of signal magnitude vector(SVM) and continuous zero-0 time are used to detect a fall. The combines a triaxial accelerometer with barometric pressure measurement is proposed in<sup>11</sup>. The algorithm proposed in<sup>11</sup> considered the barometric pressure measurement as a surrogate estimation of the change in altitude related to a fall. An efficient and intelligent fall detection system using triaxial accelerometer integrated with active RFID is proposed in<sup>12</sup>. To recognize six falling postures, a machine learning technique is employed. The neural network classifier is employed to decide the correct RFID tag position.

In this paper, fall detection algorithm that detects the actual fall direction is described. In the previous researches<sup>5-11</sup>, the acceleration values from X, Y and Z axis are used to distinguish between activities and fall directions. For example, the Signal Magnitude Vector (SMV) is calculated as the square root sum of X, Y and Z axis sample values from the accelerometer. The proposed algorithm in this paper considers either X or Y axis sample values to classify fall directions. The two peaks of the sampled X or Y axis sample are used to decide the direction of a fall. The sampled values from X and Y values are compared with various threshold values to distinguish fall directions.

The rest of the paper is organized as follows. Section 2 explains the fall detection system hardware and the fall detection algorithm. In Section 3, the fall detection measurements are summarized with various threshold values. Finally, a concluding remark is given in Section 4.

## 2. Fall Detection System

### 2.1 Hardware Description

A hardware device which composed of a triaxial accelerometer (MMA,7260, Freescale), a microcontroller (UST-MPB-Atmega128\_v5, US-Technology) with 10 bit Analog-to-Digital Converter (ADC), a bluetooth module (FB155BC, Firmtech) and a rechargeable battery was developed to collect the 3 acceleration signals. The triaxial accelerometer measures the accelerations in X, Y, and Z

axis with a sampling rate of 50 Hz. As shown in Figure 1, MMA 7260 was used to measure the accelerations. The accelerometer sensor has a range of -6g to 6g and sensitivity of 200mV/g, where g is the acceleration due to gravity. The output response and the orientation of the 3-axial accelerator are shown in Figure 2. In this paper, the orientation of the side view as shown in Figure 2 is used for acceleration measurements. In this orientation, the default acceleration values from the X and Y direction are given as 1.65V(0g) and 1.65V(0g), respectively. Similarly, the default voltage for the Z direction is given by 0.84V(-1g).

The system can measure the acceleration in 3 directions. The system has the capability of detecting the actual fall and the possible fall direction such as a front fall, a back fall, a left fall or a right fall. As mentioned earlier, the output signals from the accelerometer are sampled by ADC (Analog Digital Converter) at a rate of 50Hz. The digitized data are used to measure the accelerations of the 3 directions as shown in Figure 7. The sampled data are used to detect the actual fall and classify the direction of the fall. The fall detection system is powered by the battery. The dimensions of the developed hardware are 85X45X15mm with a weight of 80g.

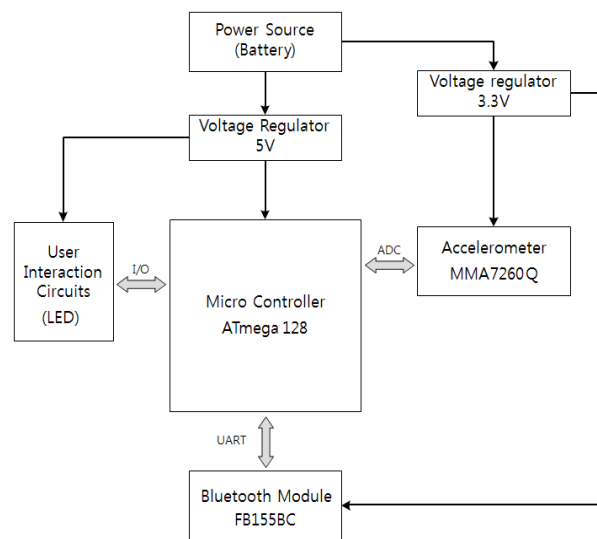

Figure 1. Block diagram of a fall detection system.

### 2.2 Fall Detection Algorithm

The algorithm detects the 4 directions such as front, back, left and right fall. As shown in Figure 2, the X direction is corresponding to the front and back direction with respect to the falling person. The Y direction corresponds

to lateral direction which corresponds to left or right direction with respect to the falling person. When a fall occurs, a sudden change of acceleration value occurs in 3 directions as shown in Figure 7 to Figure 10. As shown in Figure 7, a typical front fall gives a sudden acceleration change in X direction which results a negative peak followed by a positive peak. On the other hand, a back fall gives a positive peak followed by a negative peak as shown in Figure 8. Similarly, a typical left fall case, there is a sudden acceleration change in Y direction which results a negative peak followed by a positive peak. Similarly, the right fall results a positive peak followed by a negative peak as shown in Figure 9 and Figure 10.

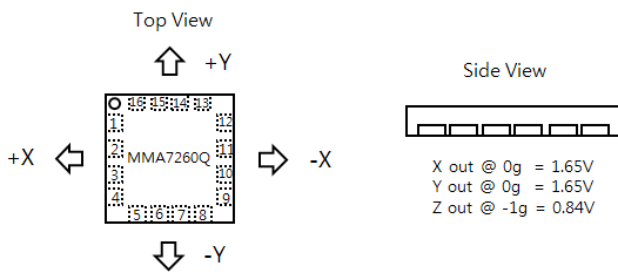

Figure 2. MMA 7260 output response and orientation.

The fall detection algorithm that can detect an actual fall and identify the direction of the fall is shown in Figure 3. The fall detection algorithm works as follows. In order to detect a fall, the algorithm detects the sudden variations in accelerations in X or Y directions. When the acceleration value reaches to the positive or negative thresholds of  $V_{Th}^P$  or  $V_{Th}^N$ , the algorithm assumes an actual fall. And, a front fall is declared when the acceleration value in X direction gives a negative peak followed by a positive peak as shown in Figure 7. A back fall is declared when the acceleration value in X direction gives a positive peak followed by a negative peak as shown in Figure 8. Similarly, in order to detect the left fall, the algorithm detects the sudden variations in accelerations in Y direction. And a left fall is declared when the acceleration values in Y direction gives a negative peak followed by a positive peak. Finally, a right fall is declared when the acceleration values in Y direction gives a positive peak followed by a negative peak as shown in Figure 9 and Figure 10.

A typical fall acceleration figure is shown in Figure 4, the positive threshold value  $V_{Th}^P$  and the negative threshold value  $V_{Th}^N$  are defined. When the acceleration value is greater than  $V_{Th}^P$ , it is assumed that a positive peak is

detected. It is assumed that a negative peak is detected when the acceleration value is less than  $V_{Th}^N$ .

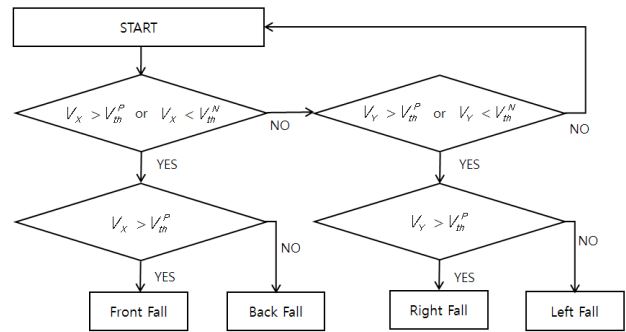

Figure 3. Fall detection algorithm.

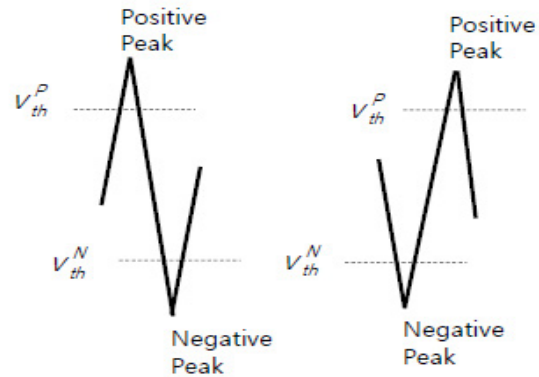

Figure 4. Threshold to detect the front and back falls.

### 3. Measurements Results

As shown in Figure 5 and Figure 5, the X and Y label represents the direction of a fall with respect to the person who wears the fall detection system. The front direction corresponds to the positive X direction denoted as +X. The back direction which corresponds to negative X direction which is denoted by -X. Similarly, the right direction corresponds to the positive Y direction denoted as +Y. The left direction corresponds to negative Y direction which is denoted by -Y. The direction of fall which lies between Front(+X) and Left(-Y) is denoted as A. The direction of fall which lies between Back(-X) and Right(+Y) is denoted as A'. Similarly, the direction of fall which lies between Front(+X) and Right(+Y) is denoted as B. The direction of fall which lies between Back(-X) and Left(-Y) is denoted as B'.

A typical front fall gravitation graphs with 3 different scenarios are drawn in Figure 7. As shown in Figure 7, the

minimum absolute value of  $V_{Th}^P$  and  $V_{Th}^N$  is set to be 1.5g to detect a positive or a negative peak for the fast fall and medium falls. For the case of slow fall, the positive and the negative peaks do not exceed the value of 1.5g. For the case of a slow fall, it is not easy to differentiate between a fall and other activities such as waking, sitting-down or standing-up. The acceleration value for the case of walking is shown in Figure 10. As shown in Figure 10, the acceleration value for a typical walking is ranging from 0g to 0.4g in the X and Y directions. The acceleration values for the case of sitting-down and standing-up cases are shown in Figure 11 and 12. The acceleration value in the X and Y directions ranges from -0.2g to 0.4g. By observing Figure 11 and Figure 12, it is obvious that the typical fall can be easily differentiated from the other daily activities such as walking, sitting-down, and standing-up.

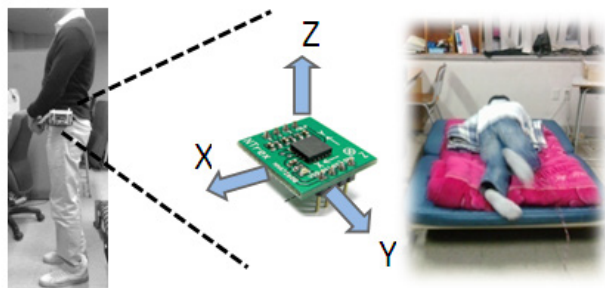

Figure 5. Picture of a front fall.

In this paper, various threshold values of  $V_{Th}^P$  and  $V_{Th}^N$  are used in the experiments. The threshold value,  $V_{Th}^P$ , is set to a positive value from 1.1g to 1.9g to detect a positive acceleration peak. On the other hand, the threshold value,  $V_{Th}^N$ , is set to a negative value from -1.1g to -1.9g to detect a negative acceleration peak. For a given direction of a fall, 20 fall experiments were performed for five sets of threshold values. Therefore, a total of 100 fall experiments are performed for a given direction of fall.

Table 1 summarizes the fall detection rate of 4 fall directions. For example, for a given threshold of  $V_{Th}^P = 1.1g$  and  $V_{Th}^N = -1.1g$ , 19 correct detection of Front fall with 1 wrong detection is observed. For a given threshold of  $V_{Th}^P = 1.3g$  and  $V_{Th}^N = -1.3g$ , 20 correct front fall detection with no wrong decision, and so on. In result, a total of 95 correct detections with 5 wrong detections are observed for the front fall. Thus, 95% of correct detection rate is observed for the front fall. For the case of back fall, 98% of correct detection rate was obtained. For the case of the left and right fall, 87% and 88% of the correct detection rate was obtained, respectively.

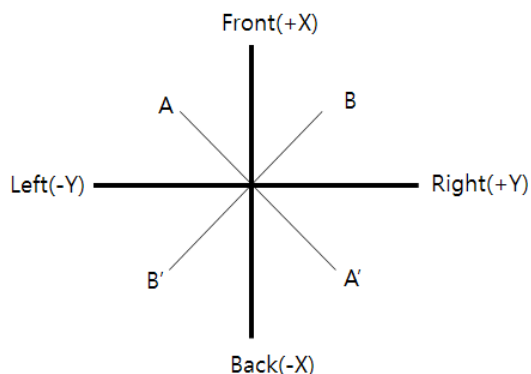

Figure 6. Fall directions.

Table 2 summarizes the detection of the fall direction of A, A', B and B' as shown in Figure 6. It is obvious that there is ambiguity of the fall direction. For example, the fall direction of A can be considered as either a front fall or a left fall. The fall direction of A' can be considered as either a back fall or a right fall. For the case of A direction, 49 out of 100 falls are detected as front falls. On the other hand, 51 falls are detected as left falls. For the case of A' direction, 49 out of 100 falls are detected as back falls. On the other hand, 51 falls are detected as right falls. Similar results are obtained for the case of B and B'.

Table 1. Fall detection rate for front, back, left, and right directions

Fall Direction	$V_{Th}^P = 1.1g$ $V_{Th}^N = -1.1g$	$V_{Th}^P = 1.3g$ $V_{Th}^N = -1.3g$	$V_{Th}^P = 1.5g$ $V_{Th}^N = -1.5g$	$V_{Th}^P = 1.7g$ $V_{Th}^N = -1.7g$	$V_{Th}^P = 1.9g$ $V_{Th}^N = -1.9g$	Detection Rate
Front Fall	19/1	20/0	20/0	19/1	17/3	95%
Back Fall	20/0	20/0	19/1	19/1	20/0	98%
Left Fall	19/1	18/2	20/2	14/6	18/2	87%
Right Fall	16/4	19/1	18/2	17/3	18/2	88%

**Table 2.** Fall detection rate for A, A', B, and B' directions

Fall Direction	$V_{Th}^P = 1.1g$ $V_{Th}^N = -1.1g$	$V_{Th}^P = 1.3g$ $V_{Th}^N = -1.3g$	$V_{Th}^P = 1.5g$ $V_{Th}^N = -1.5g$	$V_{Th}^P = 1.7g$ $V_{Th}^N = -1.7g$	$V_{Th}^P = 1.9g$ $V_{Th}^N = -1.9g$	Detection Rate
<b>A (Front Fall)</b>	Front: 11 Left: 9	Front: 9 Left: 11	Front: 11 Left: 9	Front: 10 Left: 10	Front: 10 Left: 10	49%
<b>A' (Back Fall)</b>	Back: 10 Right: 10	Back: 11 Right: 9	Back: 9 Right: 11	Back: 11 Right: 9	Back: 10 Right: 10	49%
<b>B (Front Fall)</b>	Front: 9 Left: 11	Front: 10 Left: 10	Front: 9 Left: 11	Front: 11 Left: 9	Front: 11 Left: 9	50%
<b>B' (Back Fall)</b>	Back: 10 Right: 10	Back: 9 Right: 11	Back: 9 Right: 11	Back: 9 Right: 11	Back: 9 Right: 11	48%

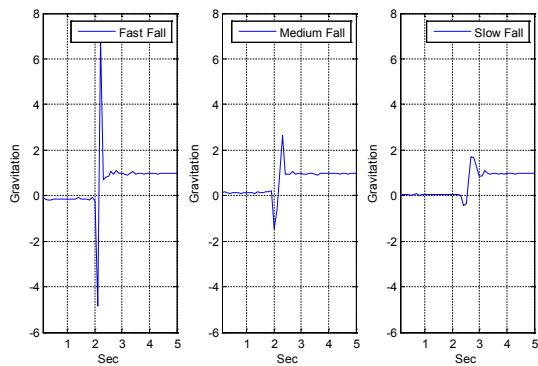

**Figure 7.** Typical forward fall measurements.

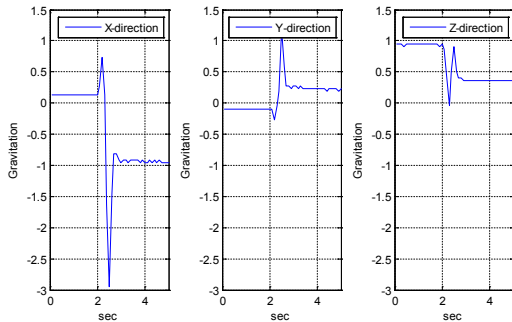

**Figure 8.** Typical back fall measurements.

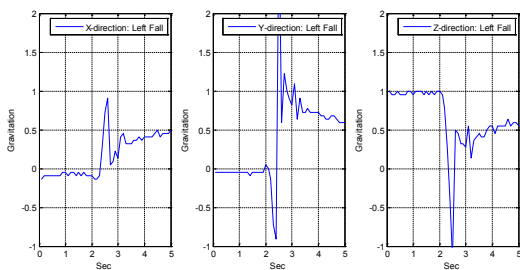

**Figure 9.** Typical left fall measurements.

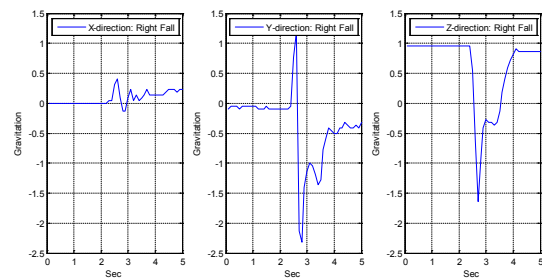

**Figure 10.** Typical right fall measurements.

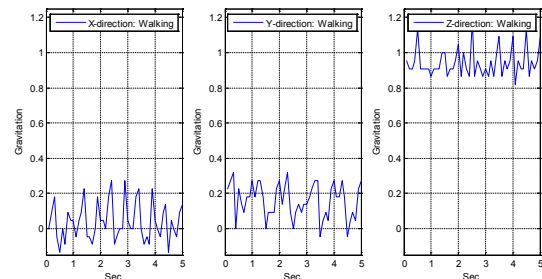

**Figure 11.** Typical walking measurements.

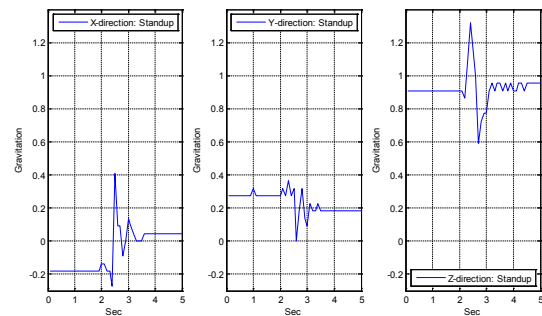

**Figure 12.** Typical stand-up measurements.

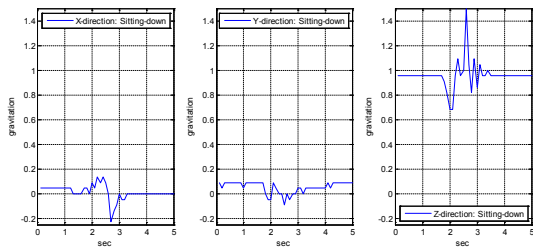

Figure 13. Typical sitting-down measurements.

## 4. Conclusion

In this paper, a simple fall detection algorithm is proposed to detect 4 types of fall directions. In order to classify the fall direction, positive and negative acceleration peaks are observed. If a negative peak is followed by a positive peak in the X direction, a front fall is assumed. If a positive peak is followed by a negative peak in the X direction, a back fall is assumed. Similarly, if a negative peak is followed by a positive peak in the Y direction, a left fall is assumed. If a positive peak is followed by a negative peak in the Y direction, a right fall is assumed. For a given fall direction, 100 falls are performed. The proposed algorithm showed 95% and 98% of detection rate in the direction of front and back fall. For the case of left and right direction fall, 87% and 88% of detection rate was obtained. For the case of the falls with direction that does not align with front, back, left, or right direction, it is not easy to determine the direction of the fall. In order to improve the detection of the fall direction, a fall detection system with both a tri-axial accelerometer and a gyroscope will be conducted in the near future.

## 5. Acknowledgement

This research was financially supported by Daegu University research grant in 2014.

## 6. References

- Zeng, Y. Environment-Based Design (EBD). ASME Conference Proceedings; 2011. p. 237–50. DOI: 10.1115/DETC2011-48263.

- Joint communication on communication on accreditation of healthcare organization (US): Joint commission international accreditation standards for hospitals. Third Edition. Illinois: The Institute; 2007
- Baker S, Harvey A. Fall injuries in the elderly. Clinics in Geriatric Medicine. 2011; 1:501–12.
- Statistics Korea; 2007.
- Karantonis DM, Narayanan MR, Mathie M, Lovell NH, Celler BG. Implementation of a real-time human movement classifier using triaxial accelerometer for ambulatory monitoring. IEEE Transaction on Information Technology in Biomedicine. 2006; 10(1):156–67.
- Chung W, Purwar A, Sharma A. Frequency domain approach for activity classification using accelerometer. IEEE EMBS Conference; 2008. p. 1120–3.
- Gupta P, Dallas T. Feature selection and activity recognition system using a single triaxial accelerometer. IEEE Transaction on Biomedical Engineering. 2014; 61(6):1780–6.
- Dumitrache M, Pasca S. Fall detection algorithm based on triaxial accelerometer data. E-Health and Bioengineering Conference(EHB); 2013. p. 1–4.
- Kau L, Chen C. A smart phone-based pocket fall accident detection, positioning, and rescue system. IEEE Journal of Biomedical and Health Information. 2015; 19(1):44–56.
- Hou Y, et al. Triaxial accelerometer-based real time fall event detection. International Conference on Information Society (i-Society); 2012. p. 386–90.
- Bianchi F, Redmond SJ, Narayanan MR, Cerutti S, Lovell NH. Barometric pressure and triaxial accelerometry-based falls event detection. IEEE Transactions on Neural Systems and Rehabilitation Engineering. 2010; 18(6):619–27.
- Hsu-Tang Kung, Ou C-Y, Li S-D, Lin C-H, Chen H-J, Hsu Y-L, Chang M-H. Efficient movement detection for human actions using triaxial accelerometer. Digest of Technical Papers International Conference on Consumer Electronics; 2010. p. 113–14
- Cheng S. An intelligent detection system using triaxial accelerometer integrated by active RFID. International Conference on Machine Learning and Cybernetics (ICMLC). 2014; 2:517–22.
- Pierleoni P, Belli A, Palma L, Pellegrini M, Pernini L, Valenti S. A high reliability wearable device for elderly fall detection. IEEE Sensors Journal. 2015; 15(8):4544–53.