

Modeling and Simulation of Five Phase Induction Motor Fed with Five Phase Inverter Topologies

B. Jyothi*, M. Venu Gopala Rao and T. Karthik

EEE Department, KL University, Greenfields, Vaddeswaram, Guntur (District) -522502, Andhra Pradesh, India;
jyothieee@kluniversity.in, venumannam@kluniversity.in, mailtotkarthik@gmail.com

Abstract

Output total harmonic distortion of the five phase inverter topologies and corresponding dynamic performance of five phase induction motor are investigated in this paper. Four types of five phase inverter topologies are simulated by using direct pulse and sinusoidal pulse width modulation methods for the inverter control. Arbitrary reference frame method has been employed to model a five phase induction motor. Special transformer connection can be used to transform the available three phase grid supply to five phases but it requires more space, frequent maintenance and high cost so inverters are preferred. Four types of five phase inverter topologies and induction motor modeling are implemented by MATLAB/Simulink. These multi-phases (more than three phases) find applications where reliability and high output power are main concern for example: ship propulsion systems, hybrid electric vehicles.

1. Introduction

The five phase systems have many advantages when compared to three phase systems. They are used in applications such as automotive, aeronautic, electric power generation, transmission and utilization. Use the even number of phases is restricted because, if we select even number of phases it reduces the motor performance because the poles coincide with each other. Also output power of the five phase supply is 2.52 times more than that of the three phase supply.

This has generated renewed interest in the development of machines having more than three phases. By employing a higher number of phases one can reduce the amplitude and increase the frequency of torque pulsations in the drive. This ensures satisfactory performance of the mechanical system of the inverter-fed motor even at lower speeds. Using the High Phase Order (HPO) concept, inverters of large power rating can be realized with existing semiconductor devices. It has also been established that the electrical efficiency of the inverter-fed HPO motors are better compared to that of a three-phase

motor. Increasing the number of phases improves the reliability since the drive can start and run even after the failure of one of the phases.

In conventional three phase supply the electrical angle between two consecutive phases is 120° . Where as in five phases the electrical angle between two consecutive phases is 72° . Thus the frequency of torque pulsations is more in five phase when compared to three phase. Thus three phase drives are limited to drive medium load applications, where as multi-phase drives¹ are used to drive large loads like ship propulsion systems, aircraft and electric vehicles. Special transformer connection^{2,3} can be used in order to transform three phase grid supply to five phase. But the size, cost and maintenance are few disadvantage of this type of transformation. In this paper, four types of inverters are simulated. First direct pulse ten-step inverter is simulated followed by SPWM inverter. Later due to the advantages of multilevel inverters compared to conventional two level inverters diode clamped and reversing voltage multilevel inverters are simulated. The output harmonic distortions of all the four inverters are observed. Finally the outputs of these four inverters are fed to five phase induction

*Author for correspondence

motor. The output torque and speed of induction motor is observed for each inverter fed induction motor.

1.1 Five Phase Inverter Topologies

1.1.1 Ten Step Inverter

Voltage source inverters have practical uses in both single-phase and three-phase applications. Single-phase VSIs utilize half-bridge and full-bridge configurations and are widely used for low power supplies, single-phase UPSs, and elaborate high-power topologies when used in multicellular configurations. Three-phase VSIs are used in applications that require sinusoidal voltage waveforms, such as ASDs, UPSs and some types of FACTS devices such as the STATCOM. They are also used in applications where arbitrary voltages are required as in the case of active filters and voltage compensators.

For the same output power as that of three phase inverter, if five phases is preferred then the power gets distributed among the legs of five phase inverter. Hence the overall ratings of the switching devices can be reduced. In this type of inverter no two switches of same leg is switched on at the same instant. Because it leads to damage of the inverter. At any instant of time three upper switches and two lower switches or three lower switches and two upper switches are switched on. The switching sequence for ten-step⁴ inverter is shown in Figure 3. It can be observed that, the width of each pulse is 180°.

In five phases ten step inverter three switches from the upper switches and two from the lower switches are turned on at a time and vice versa. So we obtained 10 modes. Each switch is conducting 36°. The two switches which form the leg of the inverter are complimentary to each other. The switches in the same leg should not conduct it will lead to short circuit. Harmonics of the order five and multiples of five are absent from both the line to line and line to neutral voltages and consequently absent from the current. The switching sequence as shown in Table 1.

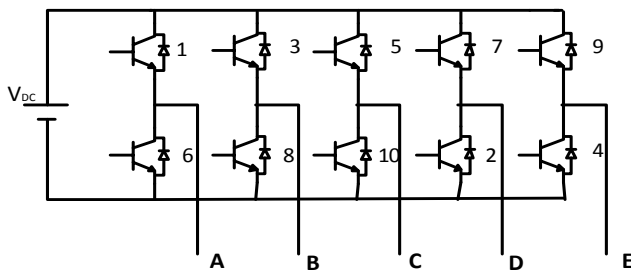

Figure 1. Five phase inverter topology.

Table 1. Switching sequence of five leg inverter

MODE	SWITCHES ON
1	1,7,8,9,10
2	8,9,10,1,2
3	9,10,1,2,3
4	10,1,2,3,4
5	1,2,3,4,5
6	2,3,4,5,6
7	3,4,5,6,7
8	4,5,6,7,8
9	5,6,7,8,9
10	6,7,8,9,10

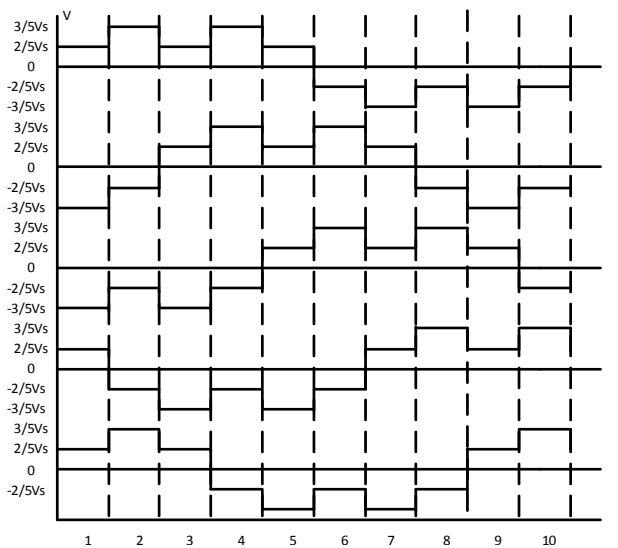

Figure 2. Voltage wave forms of five-phases ten-step inverter.

The simulation circuit is constructed similar to the Figure 1. IGBT’s are used as switching devices. Pulse generators are used to drive the gate terminals of IGBT switches. The output five phase waveforms of ten step inverter theoretical and practical are shown in Figure 2 and Figure 10a respectively.

1.1.2 Five Phase SPWM Inverter

In ten step inverter the output waveforms are similar to square wave, thus total harmonic distortion will be high. It degrades the performance of the induction motor. Hence in order to get a near sinusoidal wave Sinusoidal Pulse Width Modulation is employed. In SPWM inverter⁵ instead of feeding the gate terminals with direct pulse a

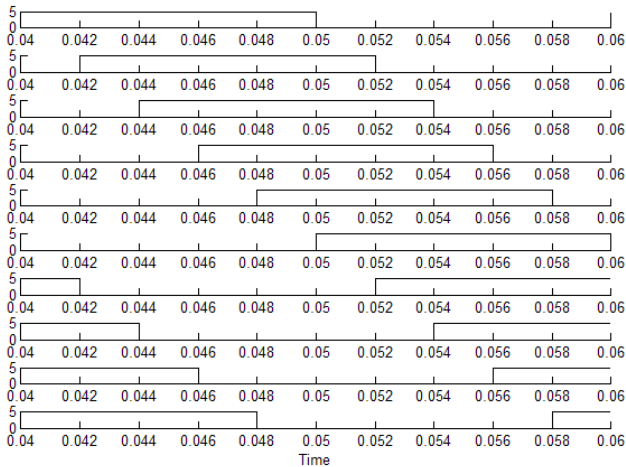

Figure 3. Switching signals for ten step inverter.

modulated pulse is fed. This modulated pulse is obtained by comparing a sinusoidal reference wave with triangular carrier wave. The output frequency can be varied by varying the frequency of the reference wave. The triggering pulses for SPWM inverter switches are shown in Figure 4.

2. Diode Clamped Multilevel Inverter

In SPWM inverter the output power is limited due to ratings of the power semiconductor switches. Where as in case of multilevel inverters the amount of withstanding voltage across switches get reduced as the number of levels increases. Therefore multilevel inverters are preferred for high power applications. Also multilevel inverters have the advantage of reducing the THD in the output waveforms.

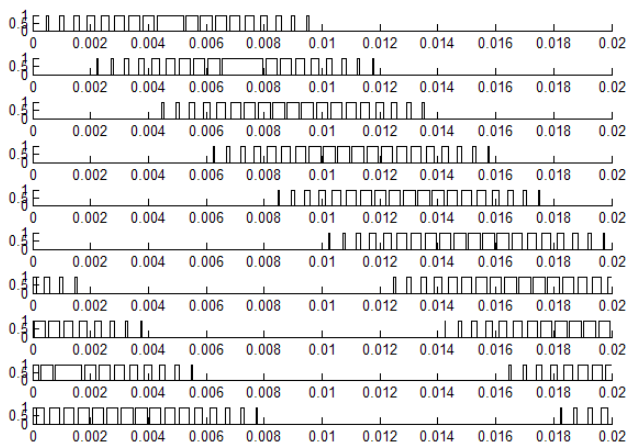

Figure 4. Switching signals for SPWM inverter.

The basic diode clamped multilevel inverter consists of two capacitors connected in series, whose junction is taken as a neutral point. This two capacitor basic model of DCMLI⁶ produces a three level output voltage of $V_{dc}/2$, 0 , $-V_{dc}/2$. In order to increase the levels of the output voltage the number of capacitors should be increased. So to produce an n-level output (n-1) capacitors are used. In this paper a five level DCMLI is employed. It consists of four capacitors. The circuit diagram of DCMLI is shown in Figure 5.

From the Table 2 it is clear that in order to get an output voltage of $V_{dc}/2$, switches a_1 , a_2 , a_3 , and a_4 should be turned on. Similarly for $V_{dc}/4$, switches a_2 , a_3 , a_4 , a_5 are turned on. For 0 volts a_3 , a_4 , a_5 , a_6 are turned on. For $-V_{dc}/4$ switches a_4 , a_5 , a_6 , a_7 are turned on. For $-V_{dc}/2$ switches a_5 , a_6 , a_7 , a_8 are on.

2.1 Reversing Voltage Type Multilevel Inverter

As the number of levels increases the total harmonic distortion of the output waveforms can be decreased. Accordingly in order to go for seven levels five phase in DCMLI it requires 60 high frequency switches, also the number of diodes will also increase. Which further increases the complexity of the circuit? In multilevel inverters the oscillating wave form with both the

Table 2. Switching sequence for five level DCMLI

a_1	a_2	a_3	a_4	a_5	a_6	a_7	a_8	V_{an}
1	1	1	1	0	0	0	0	$V_{dc}/2$
0	1	1	1	1	0	0	0	$V_{dc}/4$
0	0	1	1	1	1	0	0	0
0	0	0	1	1	1	1	0	$-V_{dc}/4$
0	0	0	0	1	1	1	1	$-V_{dc}/2$

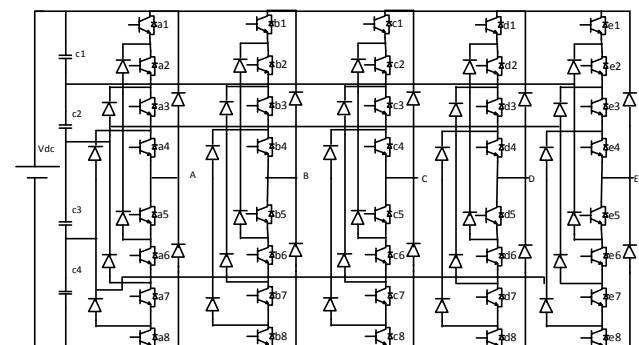

Figure 5. Five level five phases diode clamped inverter.

polarities are produced by high frequency switches. As a result the switching losses will be high. But in the case of reversing voltage multilevel inverter this problem has been rectified by employing two stage conversion. One is high frequency switching stage and other is low frequency switching stage. In high frequency switching stage a waveform with two positive polarities is generated. In low frequency switching stage the second half of the positive polarity waveform is inverted to negative half. With this type of configuration the number of high frequency switches are reduced. There by the switching losses can also be reduced.

Figure 6 shows the circuit diagram of seven level reversing voltage multilevel inverter⁹. Which consists of five high frequency legs and five low frequency bridges? This topology can be extended to higher levels by just duplicating the middle stage which consists of switches a_6 and a_3 . Another advantage of this topology is that it requires only half of the carrier wave forms that are used in conventional multilevel inverter.

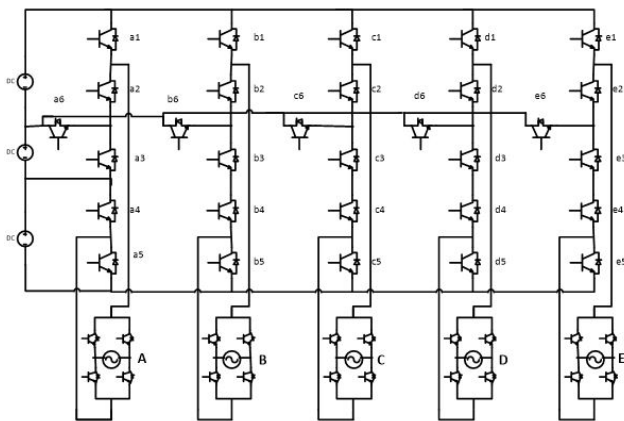

Figure 6. Reversing voltage topology for five phases inverter.

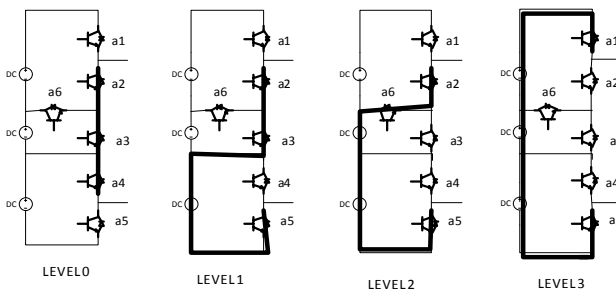

Figure 7. Switching sequences for different level generation.

2.2 Switching Sequences

As mentioned earlier RVMLI⁷ topology requires less number of carriers compared to conventional multilevel inverters. The switching sequence for level generation is shown in Figure 7. In order to generate gate pulses for the high frequency switches, three carrier waves are compared at different levels of sinusoidal reference wave. The gate signals for high frequency leg are shown in Figure 8. Two positive polarity output waveform from the high frequency leg and corresponding bipolar waveform are shown in Figure 9. The low frequency inverter switches on and off at zero crossings so the efficiency of the inverter will be increased.

3. Five Phase Induction Motor

The voltage and torque equations that describe the dynamic behavior of an induction motor are time varying.

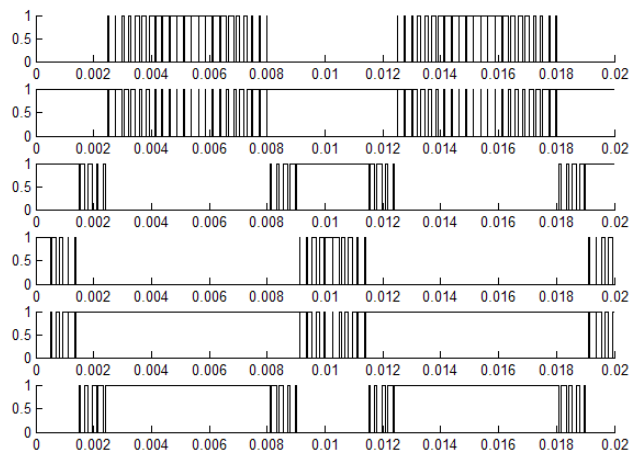

Figure 8. Switching signals for high frequency leg.

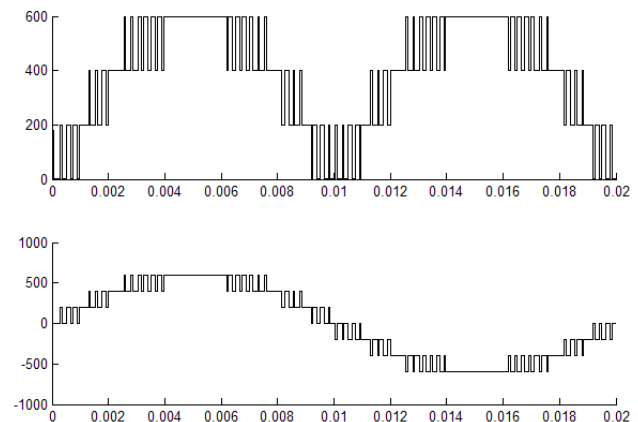

Figure 9. Output across high frequency leg and low frequency bridge.

The equations involved have some complexity; therefore change of variable⁸ can be used to reduce the complexity of these equations by eliminating all time varying inductance from the voltage equations^{9,10} of the machine. By this approach a poly phase winding can be reduce to a set of two phase winding i.e. the stator and rotor variables of the induction machine are transferred to a reference frame which may rotate at angular speed or remain stationary.

In real time it is difficult for a designer to directly make computations on hardware for required output parameters. Hence mathematical modeling of the machine helps the designer to observe the output responses for different inputs. Therefore mathematical modeling of machines has become such an important tool for machines.

4. Simulation Results

The output voltages for all the four types of inverters are simulated by using “sim power system” block sets of the Matlab/Simulink software. The inbuilt IGBT/Diode blocks are used to simulate. Inverters topologies are analyzed through their total harmonic distortions and the speed and torque curves of the motor are observed. The appropriate gate pulses are set by PWM technique and the simulation is run. It is clearly seen that the output is a balanced five-phase supply for a balanced DC supply.

The following parameters are used for the implementation of the five phase induction motor.

Stator resistance	=	0.78 Ω
Rotor resistance	=	0.66 Ω
Stator inductance	=	3.45e-3 H
Rotor inductance	=	3.45e-3 H
Mutual inductance	=	29.7e-3 H
Moment of inertia	=	0.0435 kg/m ²
Viscous friction coefficient	=	0.0435N.m.s
Number of pole	=	4

Figure 10(a) and Figure 10(b) shows the output voltage and FFT analysis of ten step inverter. Figure 10(c) shows the torque and speed curves of ten step inverter when fed to five phase induction motor. For Ten Step Inverter 200 volts dc is given as input and a 240 volts peak to peak voltage is obtained. Total harmonic distortion of output voltage is found to be 43.1%. The output torque and speed are 13.36 N-m, 1473 rpm respectively.

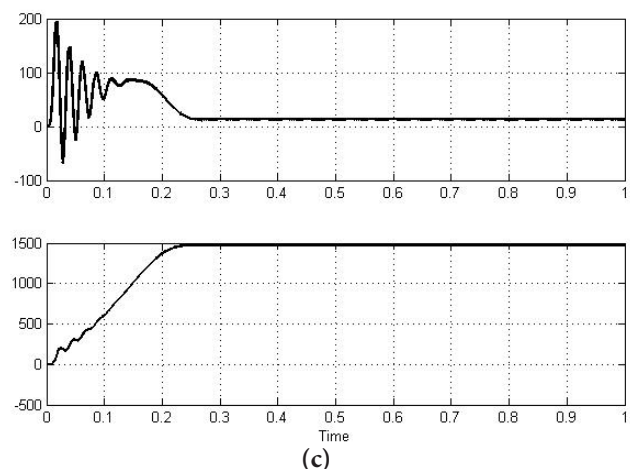
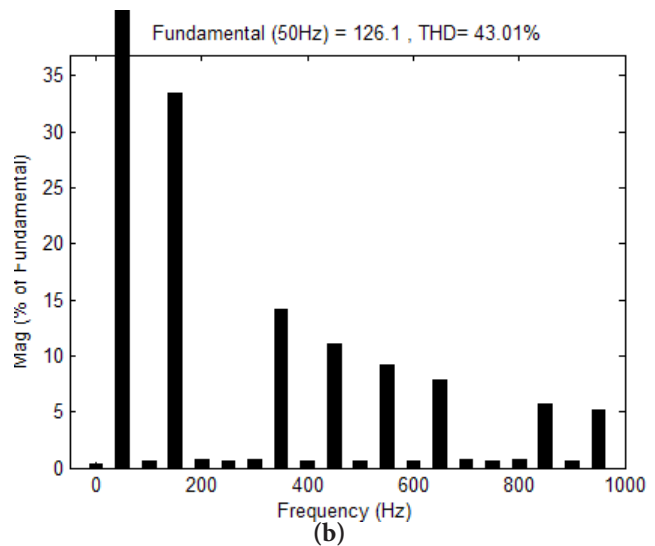
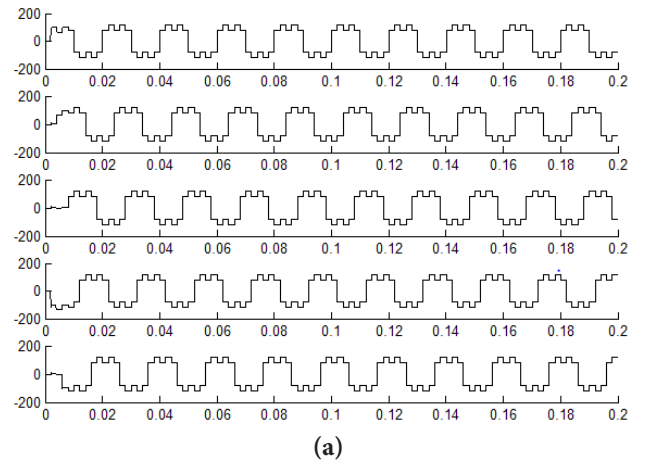

Figure 10. (a) Output voltages of five phases ten step inverter, (b) FFT analysis of five phases ten step inverter and (c) Torque and speed curves of ten step inverter fed induction motor.

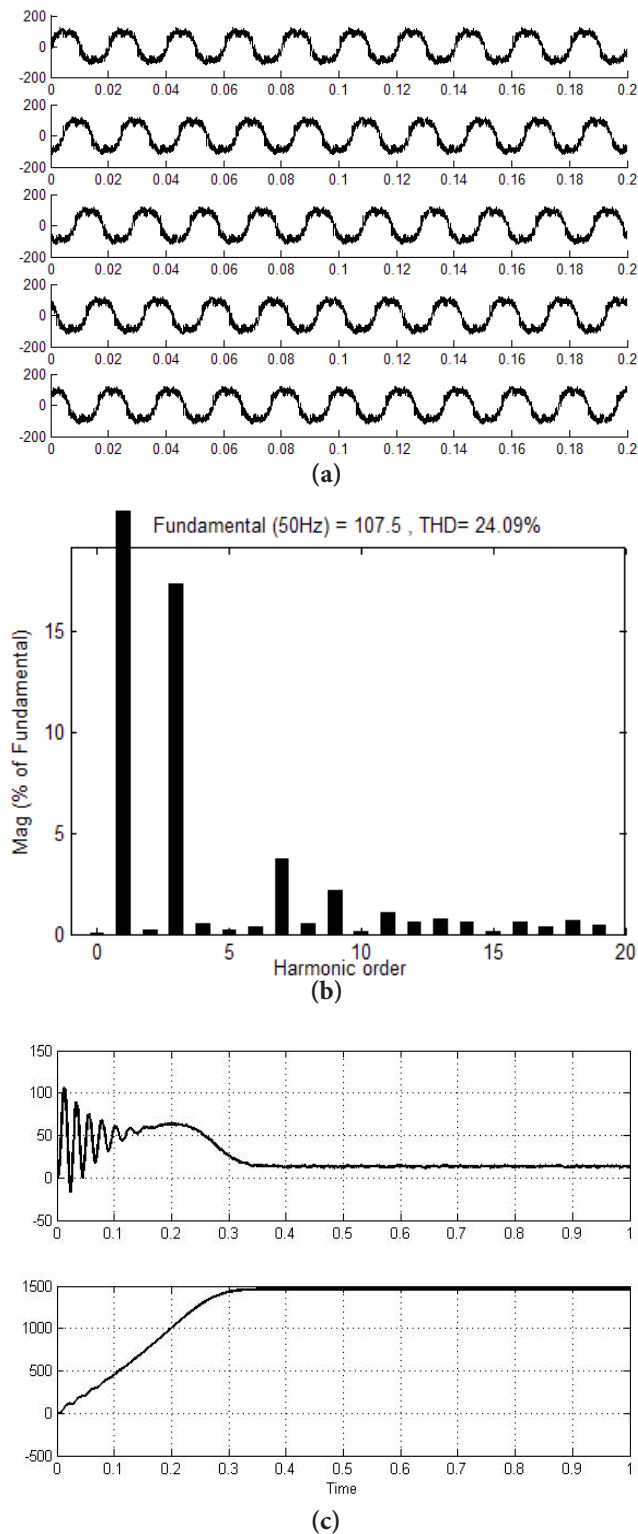
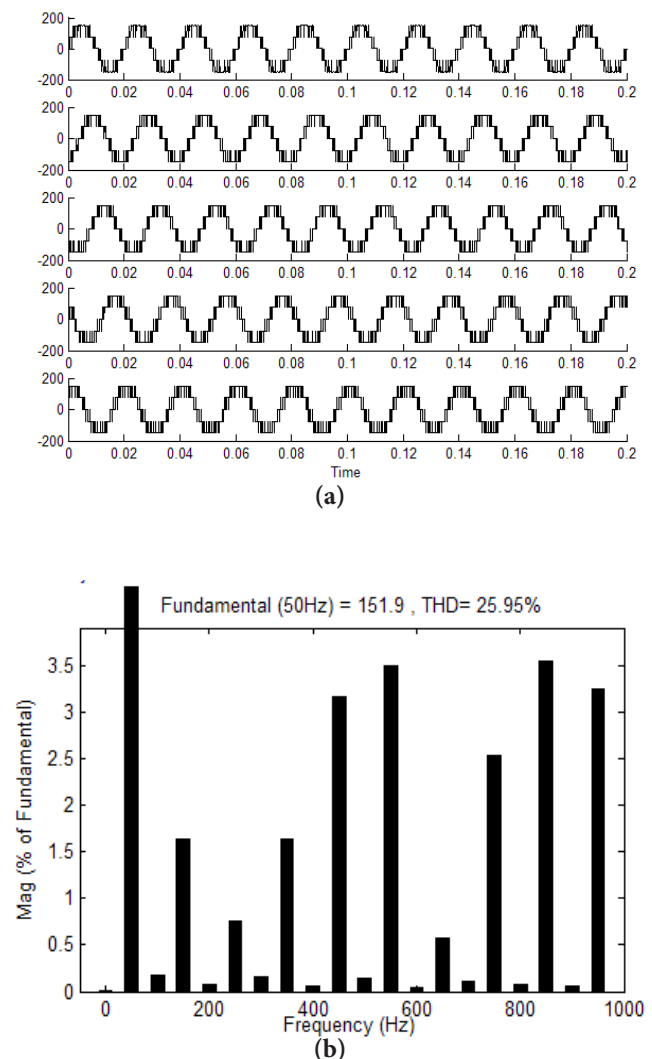

Figure 11. (a) Output voltages of five phases SPWM inverter, (b) FFT analysis of five phases SPWM inverter and (c) Torque and speed curves of SPWM inverter fed induction motor.

Figure 11(a) and Figure 11(b) shows the output voltage and FFT analysis of SPWM inverter. Figure 11(c) shows the torque and speed curves of SPWM inverter when fed to five phase induction motor. For this SPWM Inverter 200 volts dc is given as input and a 216 volts peak to peak voltage is obtained. Total harmonic distortion of output voltage is found to be 24.23%. The output torque and speed are 13.02 N-m, 1461 rpm respectively.

Figure 12(a) and Figure 12(b) shows the output voltage and FFT analysis of DCMLI. Figure 12(c) shows the torque and speed curves of DCMLI when fed to five phase induction motor. For this Diode Clamped Multilevel Inverter 300 volts dc is given as input and a 300 volts peak to peak voltage is obtained. Total harmonic distortion of output voltage is found to be 25.78%. The output torque and speed are 13.77 N-m, 1462 rpm respectively.



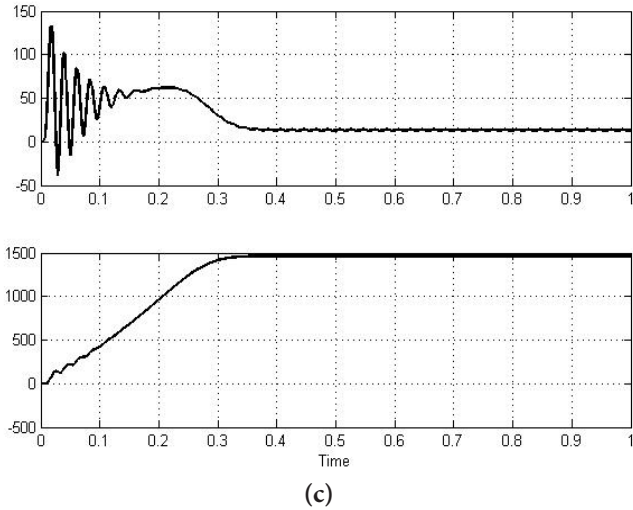

Figure 12. (a) Output voltages of five phase DCMLI, (b) FFT analysis of five phases DCMLI and (c) Torque and speed curves of DCMLI fed induction motor

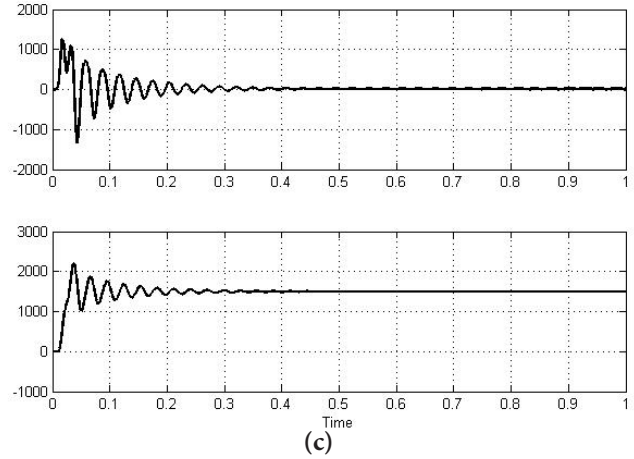
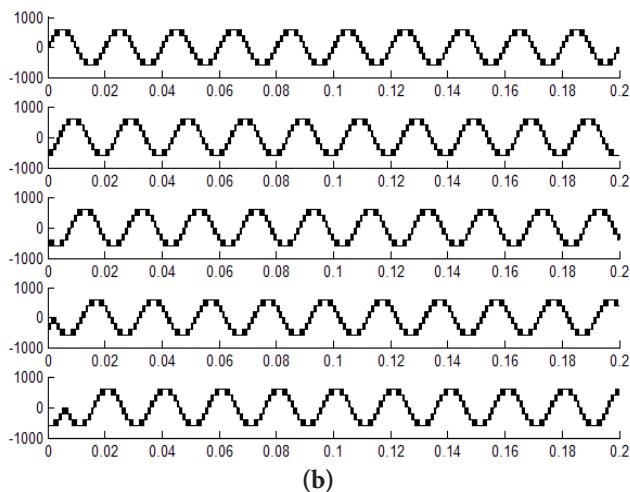
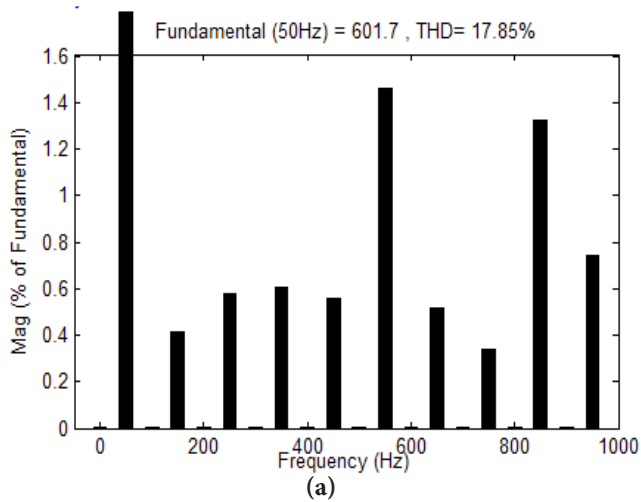

Figure 13. (a) Output voltages of five RVMLI, (b) FFT analysis of five phases RVMLI and (c) Torque and speed curves of RVMLI fed induction motor

Table 3. (%) THD of five phase inverter topologies

S.NO	FIVE PHASE INVERTER TOPOLOGY	THD(%)
1.	Ten Step Inverter	43.1%.
2.	Five Phase SPWM Inverter	24.23%.
3.	Diode Clamped Multilevel Inverter	25.78%.
4.	Reversing Voltage Multilevel Inverter	17.85%.

Figure 13(a) and figure 13(b) shows the output voltage and FFT analysis of RVMLI. Figure 13(c) shows the torque and speed curves of RVMLI when fed to five phase induction motor. For this Reversing Voltage Multilevel Inverter three 200 volts dc sources are given as input and a 1.2k volts peak to peak voltage is obtained. Total harmonic distortion of output voltage is found to be 17.85%. The output torque and speed are 13.53 N-m, 1498 rpm respectively.

5. Comparison of Five Phase Inverter Topologies

As we observe from the above four types of five phase inverter topologies the Total Harmonic Distortion (THD) are tabulated in Table 3.

6. Conclusion

The successful implementation of the proposed inverter topologies connection scheme is elaborated by using simulation results. From the above four types of five phase

inverters, reversing voltage multi-level inverter is having a less THD of 17.85% compared to the other three types. Also in order to generate a seven level wave with diode clamped multilevel inverter it requires 12 high frequency switches for each leg. So a total of 60 high frequency switches are required, also the number of diodes will also increase which makes the circuit more complex. Hence reversing voltage multilevel inverter is found to be efficient than the other three inverters.

7. References

1. Chinmaya KA, Bhasker MC, Analysis of different space vector pulse width modulation techniques for five phase inverters. Annual IEEE Indian Conference (INDICON); Pune. 2014 Dec 11-13. p. 1-6.
2. Jyothi B, Rao KPP, Surekha VN. Comparison between specially connected transformer scheme and five leg inverter. IEEE Annual India Conference INDICON; 2011 Dec 16-18, p. 1-6.
3. Iqbal A, Khan MR, Ahmed SM, Moinuddin S. A novel three-phase to five-phase transformation using a special transformer connection. IEEE Transactions on Power Delivery. 2010; 25(3):1637-44.
4. Jyothi B, Rao VGM. Comparison of five leg inverter and five phase full bridge inverter for five phase supply. IEEE ICSE 2014; 2014 Sep 19-20; Guntur: IEEE Digital Library; KL University. p. 1-4.
5. Sharma PG, Rangari S. Simulation of inverter fed five phase induction motor. International Journal of Science and Research (IJSR). 2013 Feb; 2(2):127-32.
6. Yuan X, Barbi I. Fundamentals of a new diode clamping multilevel inverter. IEEE Transactions on Power Electronics.
7. Najafi E, Yatim AHM. Design and implementation of a new multilevel inverter topology. IEEE Transactions on Industrial Electronics. 2012; 59(11):4148-54.
8. Ward EE, Harer H. Preliminary investigation of an inverter-fed 5-phase induction motor. Proceedings of the Institution Electrical Engineer; 1969 Jan. p. 980-4.
9. Levi E, Toliyat HA, Williamson. Multiphase induction motor drives- a technology status review. IET Electric Power Applications. 2007; 1(4):489-516.
10. Iqbal A, Ahmed SKM, Khan MA, Khan MR. Modeling, simulation and implementation of a five-phase induction motor drive system. Power India, Joint International Conference on Power Electronics, Drives and Energy Systems (PEDES); 2010 Dec 20-23; New Delhi. p. 1-6.