

# Development of an Embedded System to Track the Movement of Bluetooth Devices based on RSSI

Birajdar Amar Dnyanoba\*, B. Nagajayanthi and Prakash Ramachandran

School of Electronics Engineering, VIT University, Chennai - 600127,  
Tamil Nadu, India;

birajdar.amar2013@vit.ac.in, nagajayanthi.b@vit.ac.in, prakash.r@vit.ac.in

## Abstract

**Background/Objectives:** Received Signal Strength Indicator (RSSI) is used to determine the position of the Bluetooth device in an indoor environment. Much work had not been reported in tracking the movement of the device using RSSI measurements. It is proposed to design and develop a RSSI logger for a moving Bluetooth device and to analyse the data.

**Methods/Statistical Analysis:** RSSI logger is an embedded system which tracks the distance of a moving Bluetooth user by measuring and logging the RSSI in a time continuous manner. The system is designed by using Raspberry Pi and HC05 Bluetooth devices. Linux Library packages and software are used for development of this Bluetooth tracking. Designed system will plot logged RSSI data on GNUPLOT with respective to other devices. **Findings:** The graphs are obtained for movement of the device in different scenarios. There is a good coherence observed between the plotted graph and the movement pattern. This will decide behaviour of the systems. RSSI values are useful to track the movement of the person and provide service accordingly, if user comes near an entity he can be serviced, if the user goes away service can be terminated. RSSI computation capability of the Bluetooth devices and Speed of Movement analysis of system observed and calculated. This will be useful in monitoring the movement of some objects within the range of the Bluetooth devices.

**Conclusion/Improvements:** This system can be deployed to monitor and tracking objects moving in a speed of 1m/sec within the range of the Bluetooth devices in a cooperative environment.

**Keywords:** Bluetooth, Cooperative Movement, Distance, Plot, RSSI, Tracking

## 1. Introduction

Bluetooth is an industrial IEEE 802.15.1 standard for wireless personal area networks. It is designed for low power consumption and short range communication operations<sup>1</sup>. Mobile phone Bluetooth technology currently present, many embedded devices have Bluetooth feature. Bluetooth communication is RF based communication protocol<sup>1</sup>. Bluetooth gives the connection link management between two devices<sup>1</sup>. Usability study shows that people want to use more Bluetooth features and its effective usage<sup>2</sup>. Bluetooth has proved effective method for device communication, usages of Bluetooth for data transfer is quite common in present situation. If we take

survey in India 80-90% of people are using smart phones with Bluetooth facility<sup>3</sup>. Bluetooth gives coverage of 30 m. Now a days with an increasing number of Bluetooth enabled device becoming common in wireless communication technology. It gives development framework for rich hardware and software Bluetooth service applications<sup>4</sup>. Bluetooth Received Signal Strength Indicator (RSSI) is measurement of the power present in a Received radio signal RSSI of Bluetooth can be used to estimate distance between two Bluetooth devices<sup>5</sup>. RSSI is usually invisible to a user of a receiving device. However, because signal strength can vary greatly and impact functionality in wireless networking, IEEE 802.11 devices often makes the measure available to users, the RSSI is a measurement

\*Author for correspondence

of the strength of an incoming radio signal. It is a relative indicator and its units are arbitrary, but the higher the value of the RSSI, the stronger is the signal. In Bluetooth Signal strength of the Bluetooth devices can be used in many applications, such as distance measurement<sup>6</sup>. Literature survey states that some tracking based methods are Motion, it is used to detect when two devices are shaken together, either in verification mode by exchanging accelerometer time series with an Interlock protocol or in input mode by creating keys directly out of sensor time series<sup>7</sup>. Accelerometer data acquisition has been implemented for Spark Fun Electronics tilt sensors over Bluetooth, some on-mainboard sensors Windows Mobile phones through a native C implementation that communicates over TCP using the same format<sup>8</sup>. In this paper it states the use of visual output limits the range of target devices to ones that reasonably include a screen component. However, it has also been proposed to use blinking patterns of LEDs for verification of device authenticity an alternative is auditory device feedback, for example, speech generated by target devices in the Loud and Clear protocol. The limitation that sound generation can be disruptive and inappropriate. In this papers Proposed location-limited channels based on transmission media with directed and limited propagation and demonstrative identification of target devices by the user, for instance, by way of their device Physically limited channels investigated for peer authentication include infrared beams laser beams ultrasound using constraints such as distance bounding and radio environment comparison. Examples for physical selection and control by the user include pointing of their devices for target selection with laser or infrared simultaneous button press on the involved devices and use of a camera in their device to capture a visual code on the target device related object<sup>9</sup>. In this method includes Synchronous Gestures which have been proposed for setting up user interaction across devices, exemplified with bumping of one display device against another to form a shared larger display<sup>9</sup>. In this paper includes the Accelerometer based analysis of movement has also been investigated for context sensing in wearable and pervasive computing, for instance, to determine if devices are carried by the same person, to group devices that are moving together, and to identify device usage by correlation with user-worn sensors of the movement analysis algorithms introduced in these contributions, Authentication by shaking as an approach to secure pairing that is designed to exploit joint movement of devices

as shared secret<sup>10</sup>. In this paper studies the interactions among users in the presence of a cooperative file-sharing service and seeks appropriate solutions to achieve the lowest energy consumption is possible while motivating users to cooperative environment<sup>11</sup>. New rich hardware and software applications would be able to utilize this extra distance and RSSI information. This Bluetooth RSSI can be used for tracking the movement of person and provide service accordingly. For example if user comes near an entity he can be serviced if his pattern of movement is understood. It is also useful for exchanging data among devices that are close proximity cooperative motion. This paper present embedded system design, for tracking the moving Bluetooth user with RSSI logger.

## 2. System Architecture

### 2.1 SBC: Raspberry PI

For development of this embedded system Raspberry pi board is selected, which gives high speed computation capability. Raspberry Pi is a series of credit card-sized single-board computers developed in the UK by Raspberry Pi Foundation. The Raspberry Pi Model B+ incorporates a number of additional new features. It includes improved power consumption, increased connectivity with the devices and greater input output. It is small and lightweight ARM based computer. Raspberry pi has 4 USB ports, this will helpful for development of Bluetooth tracking embedded system application. Raspberry pi can be easily connected to internet this features can lead to further sending data on internet. Raspbian is free operating system, based on Debian for the Raspberry Pi hardware. An operating system is the set of basic programs and utilities that make Raspberry Pi run. It is free resource we can downward from internet and used for raspberry pi based embedded system development. Raspberry pi operating system supports open source Linux software and library packages.

### 2.2 Bluetooth HC05 Module

For development of Bluetooth tracking embedded system, Bluetooth (BT) module HC05 shown in Figure 1 is selected. HC 05 BT device works on two modes data transfer mode and AT command mode. Bluetooth module include Bluetooth SPP (Serial Port Protocol) module, particularly designed for wireless serial connection setup. This Bluetooth connection is similar to a serial port line

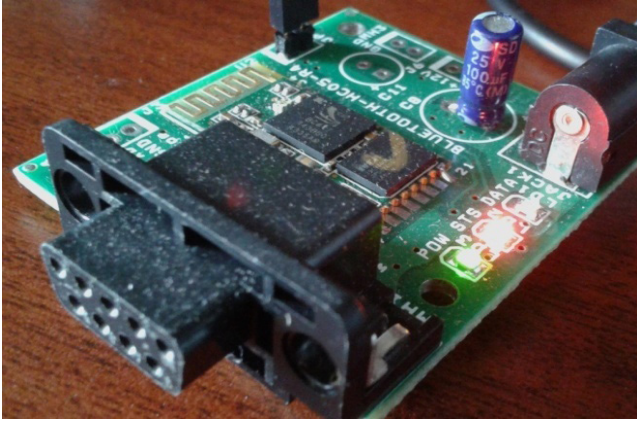

**Figure 1.** HC05 bluetooth (BT) module.

connection including RXD, TXD signals. The Bluetooth devices are mostly slave devices, such as Bluetooth printer, for proposed embedded system development master module required. Master module is capable of finding the RSSI of Bluetooth device. HC05 device works as both master and slave configuration. HC05 will work in master mode for cooperative tracking application. HC05 which works on AT commands set with baud rate 38400. After giving AT command sets it will start measuring RSSI value along with Bluetooth device id. HC 05 BT. module will find the RSSI of Bluetooth devices with respective to current positions of device.

### 3. System Implementations

#### 3.1 Hardware Design

The embedded system designed by Raspberry pi inter-

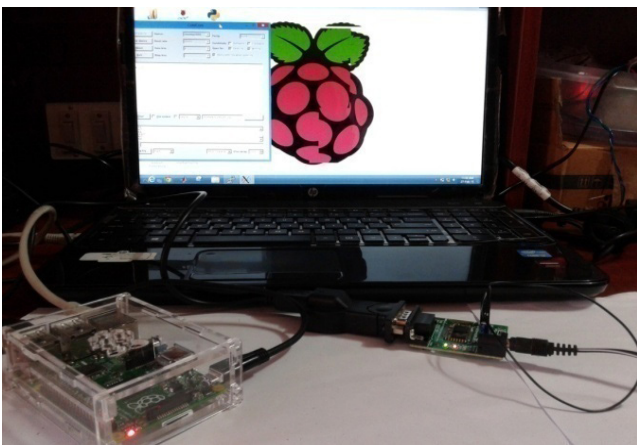
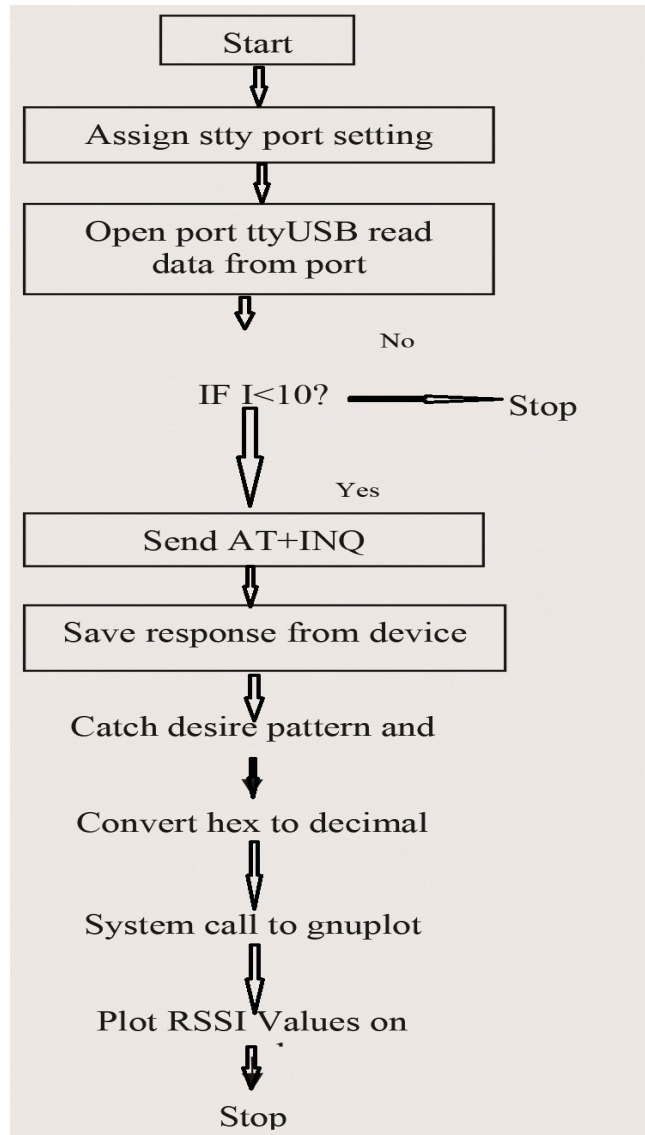

**Figure 2.** HC 05 BT interfacing with Raspberry.

faced with HC05 device, by using serial stty protocol is shown in Figure 2. STTY protocol is used in Linux based operating systems for serial communication.

#### 3.2 Program Development

Flow chart design



**Figure 3.** Flow chart.

Embedded system algorithm development completed as shown in Figure 3 Script program designed such way that, it will make automatic enquiry of nearby Bluetooth devices within the proximity area. Raspberry pi and Bluetooth devices continuously measures Received Signal Strength Indication (RSSI) values with respective to the

other Bluetooth devices. These RSSI values extracted from the sting, for further computation it is converted to weighed decimal values. RSSI values will be plotted on the graph. GNU PLOT is real time graph plotting utility used for RSSI plotting. This will decide behavior of the systems. RSSI values are useful to track the movement of the person and provide service accordingly, if user comes near an entity he can be serviced, if the user goes away service can be terminated. This will be useful in monitoring the movement of some objects within the range of the Bluetooth devices.

## 4. Result Analysis

### 4.1 RSSI v/s Distance Analysis

The objective of these experiments are to understand the possibility of using raw RSSI measurement of a Bluetooth devices with respective to host devices as a measure movement of Bluetooth devices with respective to the host devices. Testing experiments are performed for many times with different test conditions. Raspberry pi based SBC with HC05BT device is kept at center of the lab 15\*15 m as shown in Figure 4. Lab space consists of no obstacles. Experiment is performed for calculating RSSI values with respective to target mobile enable Bluetooth device. Mobile phone is used as target locations and moved on fixed interval each on 0.5 m. This movement performed up to 10.5m far away from main system.

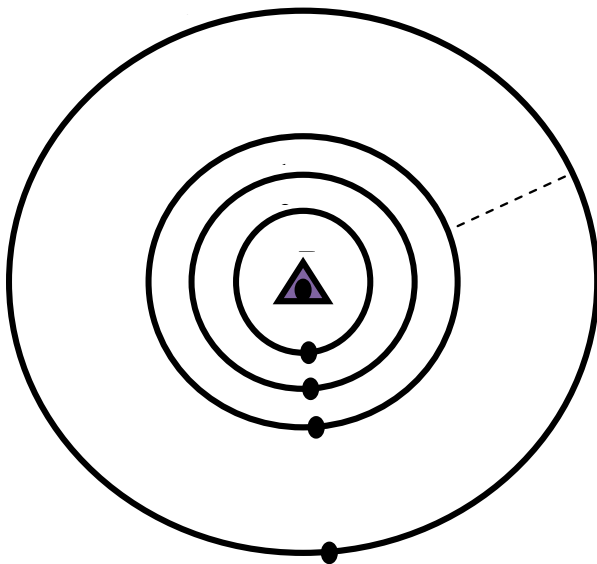

Figure 4. Experiment setup.

Table 1. RSSI v/s Distance

Distance ( m )	RSSI (dbm)	Distance ( m )	RSSI (dbm)
0	-27	5.5	-74.4
0.5	-59.2	6	-78
1	-68	6.5	-77.4
1.5	-76	7	-82.8
2	-77	7.5	-84.8
2.5	-79.6	8	-79.8
3	-75.6	8.5	-85.8
3.5	-77.8	9	-85.9
4	-75.4	9.5	-85
4.5	-71.2	10	-86.5
5	-83.2	10.5	-88

Program designed such way that at each particular point Bluetooth will find 5 RSSI values; average of these 5 values will be taken and considered as RSSI at particular point location. Table 1 show distance (m) and correspond RSSI values. From table we can say that as distance increases from Bluetooth device RSSI is falling and vice-versa. It can be observed at particular point RSSI varies with slight difference.

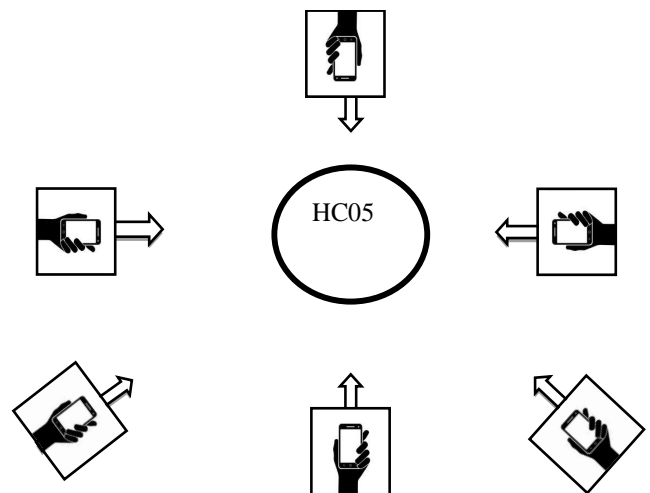

Figure 5. Cooperative motion experiment.

## 4.2 Cooperative Movement Analysis

The Cooperative motion scenario was performed for tracking moving Bluetooth user with respect to host distance. Raspberry pi based SBC with HC05 BT device is kept on lab 15\*15 m as shown in Figure 5. Mobile movement is performed towards the system with different possible angles as shown in Figure 5. Each movement was taken from 5 m distance.

In this experiment we consider the following cases:

Case 1: Mobile movement towards HC05 from front side.

In this case HC05 host system is fixed on center and cooperative motion was done from front side. Host system start reading RSSI values in between movement, it will plot received values on graph as shown in Figure 6 movement initial RSSI values are -72 to -73 dbm range and increased up to -40 to -43dbm.

Case 2: Mobile movement towards HC05 from back side.

In this case HC05 host system is fixed on center and cooperative motion was done from back side of Host system. Host start reading RSSI values in between movement, it will plot received values on graph as shown in Figure 7 initially RSSI values are -79 to -85 dbm range and increased up to -47 to -53dbm.

Case 3: Mobile movement towards HC05 from left side.

In this case HC05 host system is fixed on center and cooperative motion was performed from left side. System start reading RSSI values in between movement, it will plot received values on graph as shown in Figure 8 initial movement RSSI values are -77 to -72 dbm range and increased up to -43 to -44dbm after it start decreasing up to -51 to -54 dbm. This pattern is completely different from previous case patterns.

Case 4: Mobile Movement towards HC05 45 degree.

In this case HC05 is fixed on center and cooperative motion was performed from 45 degree left side. System start reading RSSI value and it will plot received values on graph as shown in Figure 9. Initial RSSI values are -75 to -74 dbm range, it will increased up to -44 to -45 dbm values and decreasing in within range -56 to -58 dbm values.

This pattern is completely different from previous case pattern.

Case 5: Mobile and HC05 BT moving towards each other.

In this case both HC05 BT and mobile phone are moving towards each other. Received Signal Strength (RSSI) values are increasing and unique pattern is generated on the graphs as shown in Figure 10. RSSI value starts from -79 to -68 dbm when both devices are in close proximity RSSI values are -65 to -31 dbm. When devices are complete close to each other RSSI values are constant range -30 to -32 dbm. It clearly indicates this pattern can be useful for tracking Bluetooth devices. It is very unique graphs as compared to all previous cases.

Case 6: Mobile and HC05 BT device moving away.

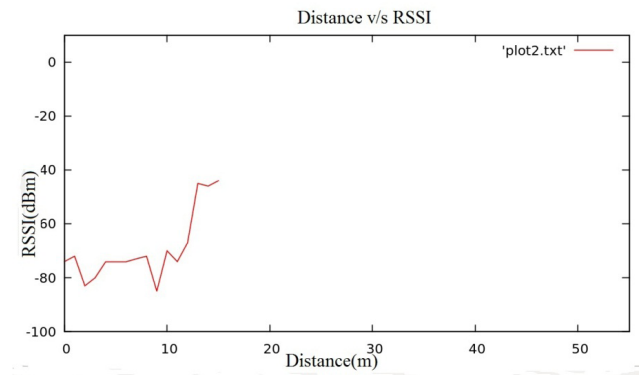

Figure 6. Plots for case 1.

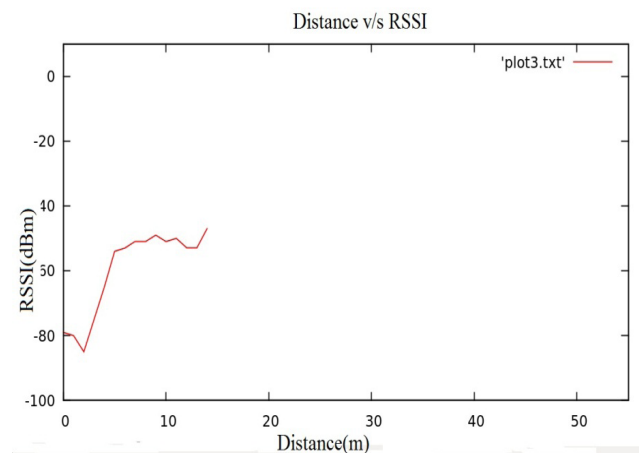

Figure 7. Plots for case 2.

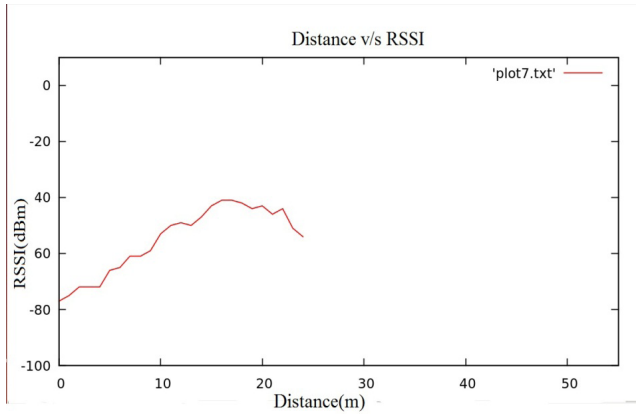

Figure 8. Plots for case 3.

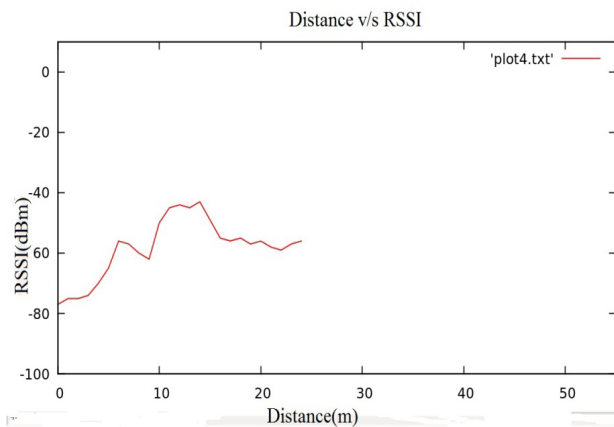

Figure 9. Plots for case 4.

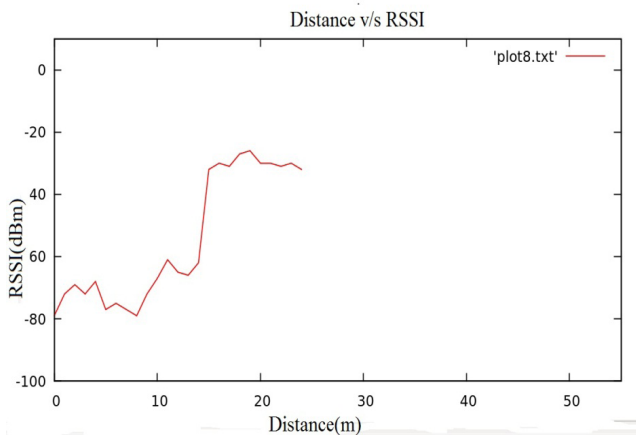

Figure 10. Plots for case 5.

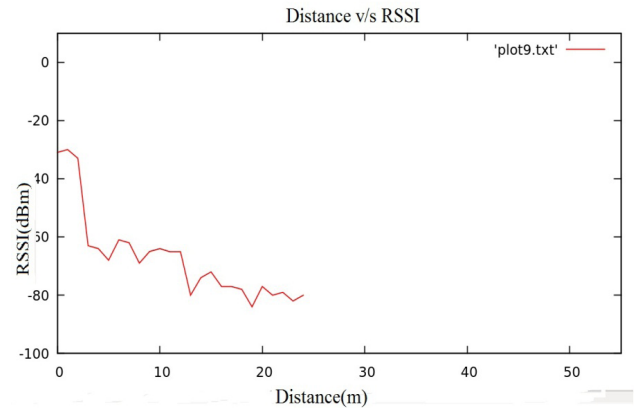

Figure 11. Plots for case 6.

In this case when both HC05 BT device and mobile moving away from each other, when they are close to each other RSSI signal strength is high in range of -31 to -33 dbm, Moving away from each other RSSI shows in range of -61 to -65 dbm. Graph nature is decreasing as shown in Figure 11. This graph is also unique pattern for this case.

The logged RSSI values are plotted in Figure 6-11 for cases 1 to 6. From the graph it can be inferred that the graphs pattern are unique for each cases and it can be decided the movement of the Bluetooth devices with respective to the host device.

### C Speed of Movement analysis

Our interest is to determine the RSSI computation capability of the system and the Bluetooth device we used. To determine this we removed all intermittent delay sub-routines and tested the performance of the system to log the RSSI data. Our experimental results are satisfactory for a device moving at a speed of 1m/sec. However we are still working on this to improve the performance and to integrate this in a product.

## 5. Conclusion

In this work it is shown that the RSSI value of moving Bluetooth devices can be logged plotted on the graphs. These graphs determine the movement of the Bluetooth devices with respective to host device. This is achieved for the Bluetooth devices moving at a speed of 1 m/s. These results are encouraged to use patterns, to decide movement of a user carrying a Bluetooth device in a cooperative environment to serve user accordingly.

## 6. References

1. Takas MK, Yoshikawa ShinOhkubo. Presence-detection method using RSSI of a bluetooth device. *International Journal of Informatics Society*. 2010; 2(1):23–31.
2. Liu H, Darabi H, Banerjee P, Liu J. Survey of wireless indoor positioning techniques. *IEEE Transactions*. 2007 Nov; 37(6):1067–80.
3. Narayanan A, Thiagarajan N, Lakhani M, Hamburg M, Boneh D. Location privacy via private proximity testing. *Proceedings of the Network and Distributed System Security Symposium*; 2011 Feb 2.
4. JanHsien Y-G, Tseng W. Accurate bluetooth positioning using weighting and large number of devices measurements. *Wireless Pers Commun*. 2014 Nov; 79(2):1129–43.
5. Taniuchi D, Liu X, Nakai D, Maekawa T. Spring model based collaborative indoor position estimation with neighbor mobile devices. *IEEE Journal*. 2015 Mar; 9(2):268–77.
6. Zhou S, Pollard JK. Position measurement using bluetooth. *IEEE Transactions on Consumer Electronics*. 2006 May; 52(2):555–8.
7. Firmansyah E, Grezelda L, Iswand. RSSI based analysis of bluetooth implementation for intra-car sensor. *6th International Conference on Information Technology and Electrical Engineering (ICITEE)*; 2014 Oct 7-8; Yogyakarta; p. 1–5.
8. Jung J, Kang D, Bae C. Distance estimation of smart device using Bluetooth. *Personal Computing Platform Research Team*. 2013; 13–18
9. Subhan F, Hasbullah H, Rozyyev A. Analysis of bluetooth signal parameters for indoor positioning systems. *International Conference on Computer and Information Science (ICCIS)*; 2012 Jun 12-14; Lumpeu; p. 784–89.
10. Subhan F, Hasbullah H, Bakhsh RA. Analysis of Bluetooth signal parameters for indoor positioning systems. *International Conference on Computer and Information Science (ICCIS)*; 2012.
11. Militano L, Romeo LP, Scarcello F. Fair cost allocation in cellular-Bluetooth Cooperation scenarios. *IEEE Transactions on Wireless Communication*. 2012 Aug; 10(8):2566–76.